

Ventose plane

Flat vacuum cups

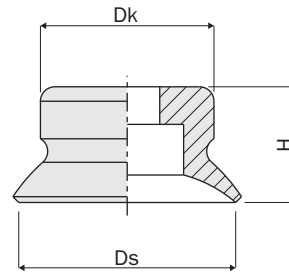

	Materiale Material	Nipplo Nipple	Ds [mm]	Dk [mm]	H [mm]	R [mm]	V [cm ³]	m [g]	F [N]
VS.PFG2NBR55N003	NBR	AVS.N003M3AG	2	4	4	2	0.001	0.1	0.12
VS.PFG2SI55N003	SIL	AVS.N003M3AG	2	4	4	2	0.001	0.1	0.12
VS.PFG3.5NBR55N003	NBR	AVS.N003M3AG	3.5	4	4	8	0.002	0.3	0.42
VS.PFG3.5SI55N003	SIL	AVS.N003M3AG	3.5	4	4	8	0.002	0.4	0.42
VS.PFG5HT160N004	HT1	AVS.N004M5AG200	5	7.5	6.5	8	0.005	0.2	0.75
VS.PFG5NBR55N004	NBR	AVS.N004M5AG200	5	7.5	6.5	8	0.005	0.2	0.75
VS.PFG5SI55N004	SIL	AVS.N004M5AG200	5	7.5	6.5	8	0.005	0.2	0.75
VS.PFG8HT160N004	HT1	AVS.N004M5AG200	8	8	7	10	0.03	0.2	2.3
VS.PFG8NBR55N004	NBR	AVS.N004M5AG200	8	8	7	10	0.03	0.2	2.3
VS.PFG8SI55N004	SIL	AVS.N004M5AG200	8	8	7	10	0.03	0.2	2.3
VS.PFG10HT160N004	HT1	AVS.N004M5AG200 AVS.N004G18AG200	10	8.5	7.5	13	0.07	0.2	4
VS.PFG10NBR55N004	NBR	AVS.N004M5AG200 AVS.N004G18AG200	10	8.5	7.5	13	0.07	0.31	4
VS.PFG10SI55N004	SIL	AVS.N004M5AG200 AVS.N004G18AG200	10	8.5	7.5	13	0.07	0.3	4
VS.PFG15HT160N005	HT1	AVS.N005G18AG200	15	12	8	13	0.4	0.7	9
VS.PFG15NBR55N005	NBR	AVS.N005G18AG200	15	12	8	13	0.4	0.7	9
VS.PFG15SI55N005	SIL	AVS.N005G18AG200	15	12	8	13	0.4	0.7	9
VS.PFG20HT160N006	HT1	AVS.N006G18AG200	20	15	10	20	0.8	1.4	15.5
VS.PFG20NBR55N006	NBR	AVS.N006G18AG200	20	15	10	20	0.8	1.5	15.5
VS.PFG20SI55N006	SIL	AVS.N006G18AG200	20	15	10	20	0.8	1.4	15.5
VS.PFG25HT160N007	HT1	AVS.N007G18AG240	25	16	14	25	1.3	2.4	26.5
VS.PFG25NBR55N007	NBR	AVS.N007G18AG240	25	16	14	25	1.3	2.2	26.5
VS.PFG25SI55N007	SIL	AVS.N007G18AG240	25	16	14	25	1.3	2.4	26.5
VS.PFG30HT160N007	HT1	AVS.N007G18AG240	28.8	14.5	12	40	1.3	3.5	34
VS.PFG30NBR55N007	NBR	AVS.N007G18AG240	28.8	14.5	12	40	1.3	3.3	34
VS.PFG30SI55N007	SIL	AVS.N007G18AG240	28.8	14.5	12	40	1.3	3.4	34
VS.PFG40HT160N007	HT1	AVS.N007G18AG240	40	24	14	50	3.8	7.6	57.7
VS.PFG40NBR55N007	NBR	AVS.N007G18AG240	40	24	14	50	3.8	7.6	57.7
VS.PFG40SI55N007	SIL	AVS.N007G18AG240	40	24	14	50	3.8	7.4	57.7
VS.PFG50HT160N008	HT1	AVS.N008G18AG240	50	28.5	15	75	7	10.6	91
VS.PFG50NBR55N008	NBR	AVS.N008G18AG240	50	28.5	15	75	7	10.2	91
VS.PFG50SI55N008	SIL	AVS.N008G18AG240	50	28.5	15	75	7	10.5	91
VS.PFG60HT160N009	HT1	AVS.N009G14AG	60	38.5	18	100	10	24.2	125
VS.PFG60NBR55N009	NBR	AVS.N009G14AG	60	38.5	18	100	10	24.7	125
VS.PFG60SI55N009	SIL	AVS.N009G14AG	60	38.5	18	100	10	23.6	125
VS.PFG80HT160N009	HT1	AVS.N009G14AG	80	52	18	150	25	51.2	260
VS.PFG80NBR55N009	NBR	AVS.N009G14AG	80	52	18	150	25	52.8	260
VS.PFG80SI55N009	SIL	AVS.N009G14AG	80	52	18	150	25	50.5	260
VS.PFG95NBR55N009	NBR	AVS.N009G14AG	95	68	19	200	35	92.4	350
VS.PFG95SI55N009	SIL	AVS.N009G14AG	95	68	19	200	35	87.9	350

Ventose piano ovali

Oval flat vacuum cups

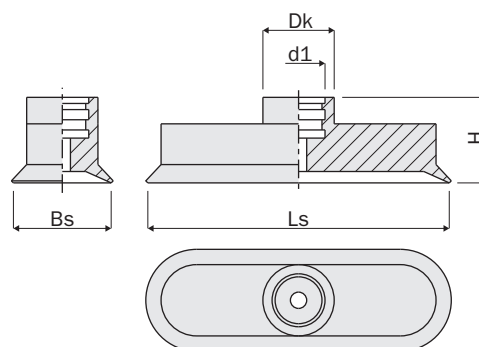
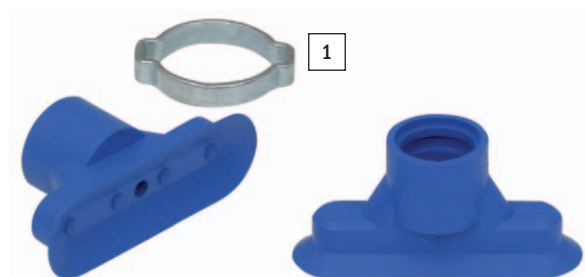

	Materiale Material	Nipplo Nipple	Dk [mm]	d1 [mm]	Bs [mm]	Ls [mm]	H [mm]	R [mm]	V [cm ³]	m [g]	F [N]
VS.SG04X2HT160N003	HT1	AVS.N003M3AG100	6	3	2	4	6	1	0.004	0.1	0.42
VS.SG04X2NBR60N003	NBR	AVS.N003M3AG100	6	3	2	4	6	1	0.004	0.1	0.42
VS.SG07X3.5HT160N003	HT1	AVS.N003M3AG100	6	3	3.5	7	6	3	0.019	0.1	1
VS.SG07X3.5NBR60N003	NBR	AVS.N003M3AG100	6	3	3.5	7	6	3	0.019	0.14	1
VS.SG015X5HT160N021	HT1	AVS.N021M5AG200	8.5	6	5	15	12	4	0.036	0.5	3.1
VS.SG015X5NBR60N021	NBR	AVS.N021M5AG200	8.5	6	5	15	12	4	0.036	0.5	3.1
VS.SG018X6HT160N021	HT1	AVS.N021M5AG200	8.5	6	6	18	12	4	0.058	0.5	4.5
VS.SG018X6NBR60N021	NBR	AVS.N021M5AG200	8.5	6	6	18	12	4	0.058	0.5	4.5
VS.SG024X8HT160N022	HT1	AVS.N022G18AG350	11.5	7	8	24	12	8	0.138	2.6	8
VS.SG024X8NBR60N022	NBR	AVS.N022G18AG350	11.5	7	8	24	12	8	0.138	2.6	8
VS.SG030X10HT160N022	HT1	AVS.N022G18AG350	11.5	7	10	30	12	8	0.28	2.8	12.2
VS.SG030X10NBR60N022	NBR	AVS.N022G18AG350	11.5	7	10	30	12	8	0.28	2.7	12.2
VS.SG045X15HT160N023	HT1	AVS.N023G14AG350	15.5	13	15	45	21	10	0.98	6.3	28.2
VS.SG045X15NBR60N023	NBR	AVS.N023G14AG350	15.5	13	15	45	21	10	0.98	6.3	28.2
VS.SG060X20HT160N023	HT1	AVS.N023G14AG350	15.5	13	20	60	21	20	2.3	9.7	50.1
VS.SG060X20NBR60N023	NBR	AVS.N023G14AG350	15.5	13	20	60	21	20	2.3	9.6	50.1
VS.SG075X25HT160N023	HT1	AVS.N023G14AG350	17.5	13	25	75	21	30	4.7	17.8	78.3
VS.SG075X25NBR60N023	NBR	AVS.N023G14AG350	17.5	13	25	75	21	30	4.7	17.8	78.3
VS.SG090X30NBR70N023	NBR	AVS.N023G14AG350	17.5	13	30	90	21	35	8.5	26	112.6

Morsetto a due orecchie per ventose ovali

Two-ear clamp for oval vacuum cups

	Materiale Material	Dk [mm]	m [g]
VS.ZOKL1113	Acciaio zincato Galvanised steel	11÷13	1.7
VS.ZOKL1518	Acciaio zincato Galvanised steel	15÷18	2.56

Ventose con 1.5 soffietti

Vacuum cups with 1.5 bellows

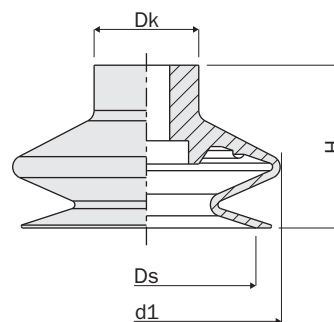

	Materiale Material	Nippolo Nipple	Dk [mm]	d1 [mm]	Ds [mm]	H [mm]	R [mm]	V [cm ³]	m [g]	F [N]
VS.FGA11HT160N016	HT1	AVS.N016G18AG350 AVS.N016M5AG250	10	12	10.4	16	10	0.225	0.9	0.95
VS.FGA11NBR55N016	NBR	AVS.N016G18AG350 AVS.N016M5AG250	10	12	10.4	16	10	0.225	0.9	0.95
VS.FGA11SI55N016	SIL	AVS.N016G18AG350 AVS.N016M5AG250	10	12	10.4	16	10	0.225	0.8	0.95
VS.FGA16HT160N016	HT1	AVS.N016G18AG350 AVS.N016M5AG250	10	17	15.6	19.2	20	0.75	1.2	2.3
VS.FGA16NBR55N016	NBR	AVS.N016G18AG350 AVS.N016M5AG250	10	17	15.6	19.2	20	0.75	1.3	2.3
VS.FGA16SI55N016	SIL	AVS.N016G18AG350 AVS.N016M5AG250	10	17	15.6	19.2	20	0.75	1.2	2.3
VS.FGA22HT160N016	HT1	AVS.N016G18AG350 AVS.N016M5AG250	10	24.2	21.5	19	25	1.4	1.9	5.7
VS.FGA22NBR55N016	NBR	AVS.N016G18AG350 AVS.N016M5AG250	10	24.2	21.5	19	25	1.4	1.9	5.7
VS.FGA22SI55N016	SIL	AVS.N016G18AG350 AVS.N016M5AG250	10	24.2	21.5	19	25	1.4	1.8	5.7
VS.FGA33HT160N018	HT1	AVS.N018G14AG440	18	36	30	27	40	4.75	7.3	13.6
VS.FGA33NBR55N018	NBR	AVS.N018G14AG440	18	36	30	27	40	4.75	7.3	13.6
VS.FGA33SI55N018	SIL	AVS.N018G14AG440	18	36	30	27	40	4.75	7	13.6
VS.FGA43HT160N018	HT1	AVS.N018G14AG440	18	45.9	38	27.6	60	9.25	11.5	22.8
VS.FGA43NBR55N018	NBR	AVS.N018G14AG440	18	45.9	38	27.6	60	9.25	11.6	22.8
VS.FGA43SI55N018	SIL	AVS.N018G14AG440	18	45.9	38	27.6	60	9.25	11	22.8
VS.FGA53HT160N018	HT1	AVS.N018G14AG440	18	58.6	50	34	75	26.25	19.4	51.3
VS.FGA53NBR55N018	NBR	AVS.N018G14AG440	18	58.6	50	34	75	26.25	19.3	51.3
VS.FGA53SI55N018	SIL	AVS.N018G14AG440	18	58.6	50	34	75	26.25	18.4	51.3
VS.FGA78HT160N019	HT1	AVS.N019G14AG	25	83	74	47	70	76	60	137.4
VS.FGA78NBR55N019	NBR	AVS.N019G14AG	25	83	74	47	70	76	58.4	137.4
VS.FGA78SI55N019	SIL	AVS.N019G14AG	25	83	74	47	70	76	54.3	137.4

Materiali

Materials

	Colore Color	Durezza Hardness	Temperatura di esercizio Temperature range
Materiale antialone / Non-marking material	HT1 Blu / Blue	60 Sh.A	-25° ÷ +170° C
Gomma nitrilica / Nitrile rubber	NBR Nero / Black	55/60/70 Sh.A	-30° ÷ +120° C
Silicone / Silicone	SIL Trasparente / Translucent	55 Sh.A	-50° ÷ +220° C

R Il raggio della più piccola sfera prendibile
Radius of the smallest grippable ball

V Il volume interno
The inner volume

m Peso
Weight

F Forza di sollevamento a -0.6bar
Suction force at -0.6bar

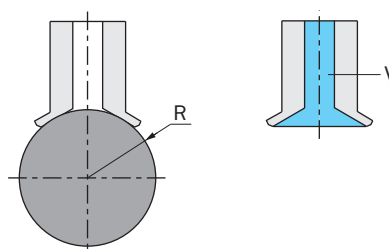

Ventose con 2.5 soffietti

Vacuum cups with 2.5 bellows

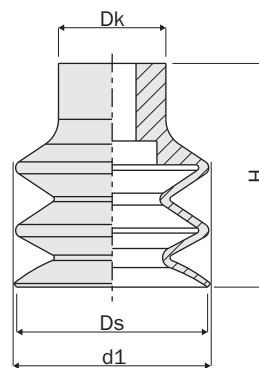

	Materiale Material	Nipplo Nipple	Dk [mm]	d1 [mm]	Ds [mm]	H [mm]	R [mm]	V [cm ³]	m [g]	F [N]
VS.FG5HT160N017	HT1	AVS.N017M5AG200	7	6	5	14	8	0.033	0.3	0.1
VS.FG5NBR55N017	NBR	AVS.N017M5AG200	7	6	5	14	8	0.033	0.3	0.1
VS.FG5SI55N017	SIL	AVS.N017M5AG200	7	6	5	14	8	0.033	0.3	0.1
VS.FG9HT160N016	HT1	AVS.N016G18AG350 AVS.N016M5AG250	9	8.9	9	15	10	0.15	0.6	0.7
VS.FG9NBR55N016	NBR	AVS.N016G18AG350 AVS.N016M5AG250	9	8.9	9	15	10	0.15	0.6	0.7
VS.FG9SI55N016	SIL	AVS.N016G18AG350 AVS.N016M5AG250	9	8.9	9	15	10	0.15	0.6	0.7
VS.FG12HT160N016	HT1	AVS.N016G18AG350 AVS.N016M5AG250	10	12	12	21	13	0.6	1.1	0.9
VS.FG12NBR55N016	NBR	AVS.N016G18AG350 AVS.N016M5AG250	10	12	12	21	13	0.6	1.1	0.9
VS.FG12SI55N016	SIL	AVS.N016G18AG350 AVS.N016M5AG250	10	12	12	21	13	0.6	1.1	0.9
VS.FG14HT160N016	HT1	AVS.N016G18AG350 AVS.N016M5AG250	10	13.9	14.5	22.8	15	0.975	1.4	1.2
VS.FG14NBR55N016	NBR	AVS.N016G18AG350 AVS.N016M5AG250	10	13.9	14.5	22.8	15	0.975	1.4	1.2
VS.FG14SI55N016	SIL	AVS.N016G18AG350 AVS.N016M5AG250	10	13.9	14.5	22.8	15	0.975	1.3	1.2
VS.FG18HT160N016	HT1	AVS.N016G18AG350 AVS.N016M5AG250	10	17.8	17.2	22.6	20	1.35	1.9	2.3
VS.FG18NBR55N016	NBR	AVS.N016G18AG350 AVS.N016M5AG250	10	17.8	17.2	22.6	20	1.35	2.1	2.3
VS.FG18SI55N016	SIL	AVS.N016G18AG350 AVS.N016M5AG250	10	17.8	17.2	22.6	20	1.35	1.9	2.3
VS.FG20HT160N016	HT1	AVS.N016G18AG350 AVS.N016M5AG250	10	20	20	22.1	30	2	2	3.8
VS.FG20NBR55N016	NBR	AVS.N016G18AG350 AVS.N016M5AG250	10	20	20	22.1	30	2	2.2	3.8
VS.FG20SI55N016	SIL	AVS.N016G18AG350 AVS.N016M5AG250	10	20	20	22.1	30	2	2	3.8
VS.FG32HT160N018	HT1	AVS.N018G14AG440	18	32.6	32	37.5	35	10	9.5	12
VS.FG32NBR55N018	NBR	AVS.N018G14AG440	18	32.6	32	37.5	35	10	9.6	12
VS.FG32SI55N018	SIL	AVS.N018G14AG440	18	32.6	32	37.5	35	10	9	12
VS.FG42HT160N018	HT1	AVS.N018G14AG440	18	43.5	42.6	46	75	19.5	20.9	13.6
VS.FG42NBR55N018	NBR	AVS.N018G14AG440	18	43.5	42.6	46	75	19.5	22.5	13.6
VS.FG42SI55N018	SIL	AVS.N018G14AG440	18	43.5	42.6	46	75	19.5	20.6	13.6
VS.FG62HT160N018	HT1	AVS.N018G14AG440	18	62	62	54	75	72.5	40.3	39.6
VS.FG62NBR55N018	NBR	AVS.N018G14AG440	18	62	62	54	75	72.5	42.1	39.6
VS.FG62SI55N018	SIL	AVS.N018G14AG440	18	62	62	54	75	72.5	38.1	39.6
VS.FG88NBR55N019	NBR	AVS.N019G14AG	25	88.2	89	86.5	100	165	166.6	45.2
VS.FG88SI55N019	SIL	AVS.N019G14AG	25	88.2	89	86.5	100	165	155.6	45.2

Nippli (per ventose serie VS.)

Nipples (for vacuum cups series VS.)

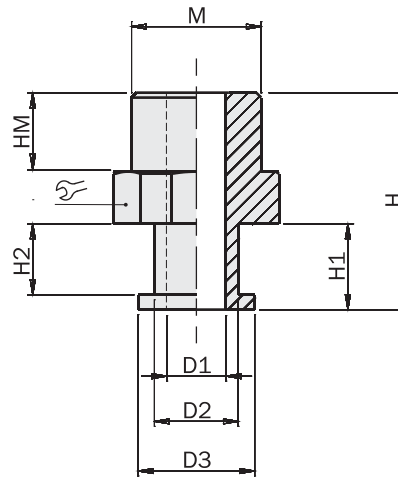
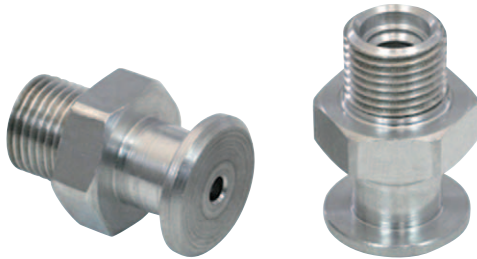

	M	D1 [mm]	D2 [mm]	D3 [mm]	H [mm]	H1 [mm]	H2 [mm]	HM [mm]	⌀ [mm]	Peso Weight
AVS.N003M3AG100	M3	1	2	3.2	7.5	2.5	1.5	3	5	0.18 g
AVS.N004M5AG200	M5	2	4	6	13.5	4	2	4.5	8	1.05 g
AVS.N004G18AG200	1/8	2	4	6	17	4	2	8	14	3.8 g
AVS.N005G18AG200	1/8	2	5	8	17.5	4.5	2.5	8	14	4.05 g
AVS.N006G18AG200	1/8	2	5	10	19.5	6.5	4.5	8	14	4.3 g
AVS.N007G18AG240	1/8	2.4	6.5	10	21.5	8.5	7	8	14	3.8 g
AVS.N008G18AG240	1/8	2.4	8.5	14	22	9	7	8	14	4.7 g
AVS.N009G14AG	1/4	5.5	10x1.25	-	25	10	-	10	17	9.3 g
AVS.N023G14AG350	1/4	3.5	12	13.5	25	10	8	10	17	9.6 g
AVS.N022G18AG350	1/8	3.5	6	7.5	18.5	4.5	2	8	14	3.8 g
AVS.N021M5AG200	M5	2	5	6.5	15.5	4.5	2	5	8	1.2 g
AVS.N016M5AG250	M5	2.5	5.8	6.5	16	6	3.5	5	7	1.02 g
AVS.N017M5AG200	M5	2	4.2	4.5	17	7	4	5	8	1.1 g
AVS.N018G14AG440	1/4	4.4	8.7	14	28.8	13.8	12.3	11	17	7.75 g
AVS.N019G14AG	1/4	8.2	13.5	20	40	23	19	11	21	14.2 g
AVS.N016G18AG350	1/8	3.5	5.8	6.5	20	6.5	4	7.5	14	4.13 g

Ventose plane con nipplo

Flat vacuum cups with nipple

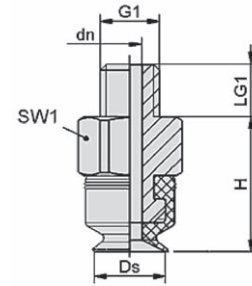
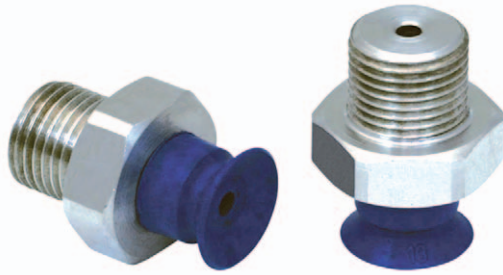

	Ventosa Vacuum cup	Nipplo Nipple	G1	dn	Ds	H	LG1	SW1	R	V	m	F
			[mm]	[mm]	[mm]	[mm]	[mm]	[mm]	[mm]	[cm ³]	[g]	[N]
WS.PFYN2NBR55M3AG	VS.PFG2NBR55N003	AVS.N003M3AG	M3	1	2	6	3.17	5	2	0.001	0.28	0.12
WS.PFYN2SI55M3AG	VS.PFG2SI55N003	AVS.N003M3AG	M3	1	2	6	3.17	5	2	0.001	0.28	0.12
WS.PFYN3.5NBR55M3AG	VS.PFG3.5NBR55N003	AVS.N003M3AG	M3	1	3.5	6	3.17	5	8	0.002	0.48	0.42
WS.PFYN3.5SI55M3AG	VS.PFG3.5SI55N003	AVS.N003M3AG	M3	1	3.5	6	3.17	5	8	0.002	0.58	0.42
WS.PFYN5HT160M5AG	VS.PFG5HT160N004	AVS.N004M5AG200	M5	2	5	11.5	4.5	8	8	0.005	1.25	0.75
WS.PFYN5NBR55M5AG	VS.PFG5NBR55N004	AVS.N004M5AG200	M5	2	5	11.5	4.5	8	8	0.005	1.25	0.75
WS.PFYN5SI55M5AG	VS.PFG5SI55N004	AVS.N004M5AG200	M5	2	5	11.5	4.5	8	8	0.005	1.25	0.75
WS.PFYN8HT160M5AG	VS.PFG8HT160N004	AVS.N004M5AG200	M5	2	8	12	4.5	8	10	0.03	1.25	2.3
WS.PFYN8NBR55M5AG	VS.PFG8NBR55N004	AVS.N004M5AG200	M5	2	8	12	4.5	8	10	0.03	1.25	2.3
WS.PFYN8SI55M5AG	VS.PFG8SI55N004	AVS.N004M5AG200	M5	2	8	12	4.5	8	10	0.03	1.25	2.3
WS.PFYN10HT160G18AG	VS.PFG10HT160N004	AVS.N004G18AG200	1/8	2	10	12.5	8	14	13	0.07	4	4
WS.PFYN10HT160M5AG	VS.PFG10HT160N004	AVS.N004M5AG200	M5	2	10	12.5	4.5	8	13	0.07	1.36	4
WS.PFYN10NBR55G18AG	VS.PFG10NBR55N004	AVS.N004G18AG200	1/8	2	10	12.5	8	14	13	0.07	4.1	4
WS.PFYN10NBR55M5AG	VS.PFG10NBR55N004	AVS.N004M5AG200	M5	2	10	12.5	4.5	8	13	0.07	1.25	4
WS.PFYN10SI55G18AG	VS.PFG10SI55N004	AVS.N004G18AG200	1/8	2	10	12.5	8	14	13	0.07	4.11	4
WS.PFYN10SI55M5AG	VS.PFG10SI55N004	AVS.N004M5AG200	M5	2	10	12.5	4.5	8	13	0.07	1.35	4
WS.PFYN15HT160G18AG	VS.PFG15HT160N005	AVS.N005G18AG200	1/8	2	15	13	8	14	13	0.4	4.75	9
WS.PFYN15NBR55G18AG	VS.PFG15NBR55N005	AVS.N005G18AG200	1/8	2	15	13	8	14	13	0.4	4.75	9
WS.PFYN15SI55G18AG	VS.PFG15SI55N005	AVS.N005G18AG200	1/8	2	15	13	8	14	13	0.4	4.75	9
WS.PFYN20HT160G18AG	VS.PFG20HT160N006	AVS.N006G18AG200	1/8	2	20	15	8	14	20	0.8	5.7	15.5
WS.PFYN20NBR55G18AG	VS.PFG20NBR55N006	AVS.N006G18AG200	1/8	2	20	15	8	14	20	0.8	5.8	15.5
WS.PFYN20SI55G18AG	VS.PFG20SI55N006	AVS.N006G18AG200	1/8	2	20	15	8	14	20	0.8	5.7	15.5
WS.PFYN25HT160G18AG	VS.PFG25HT160N007	AVS.N007G18AG240	1/8	2.4	25	19	8	14	25	1.3	6.2	26.5
WS.PFYN25NBR55G18AG	VS.PFG25NBR55N007	AVS.N007G18AG240	1/8	2.4	25	19	8	14	25	1.3	6	26.5
WS.PFYN25SI55G18AG	VS.PFG25SI55N007	AVS.N007G18AG240	1/8	2.4	25	19	8	14	25	1.3	6.2	26.5
WS.PFYN30HT160G18AG	VS.PFG30HT160N007	AVS.N007G18AG240	1/8	2.4	28.8	17	8	14	40	1.3	7.3	34
WS.PFYN30NBR55G18AG	VS.PFG30NBR55N007	AVS.N007G18AG240	1/8	2.4	28.8	17	8	14	40	1.3	7.1	34
WS.PFYN30SI55G18AG	VS.PFG30SI55N007	AVS.N007G18AG240	1/8	2.4	28.8	17	8	14	40	1.3	7.2	34
WS.PFYN40HT160G18AG	VS.PFG40HT160N007	AVS.N007G18AG240	1/8	2.4	40	19	8	14	50	3.8	11.4	57.7
WS.PFYN40NBR55G18AG	VS.PFG40NBR55N007	AVS.N007G18AG240	1/8	2.4	40	19	8	14	50	3.8	11.4	57.7
WS.PFYN40SI55G18AG	VS.PFG40SI55N007	AVS.N007G18AG240	1/8	2.4	40	19	8	14	50	3.8	11.2	57.7
WS.PFYN50HT160G18AG	VS.PFG50HT160N008	AVS.N008G18AG240	1/8	2.4	50	20	8	14	75	7	10.6	91
WS.PFYN50NBR55G18AG	VS.PFG50NBR55N008	AVS.N008G18AG240	1/8	2.4	50	20	8	14	75	7	10.2	91
WS.PFYN50SI55G18AG	VS.PFG50SI55N008	AVS.N008G18AG240	1/8	2.4	50	20	8	14	75	7	10.5	91
WS.PFYN60HT160G14AG	VS.PFG60HT160N009	AVS.N009G14AG	1/4	5.5	60	23	10	17	100	10	24.2	125
WS.PFYN60NBR55G14AG	VS.PFG60NBR55N009	AVS.N009G14AG	1/4	5.5	60	23	10	17	100	10	24.7	125
WS.PFYN60SI55G14AG	VS.PFG60SI55N009	AVS.N009G14AG	1/4	5.5	60	23	10	17	100	10	23.6	125
WS.PFYN80NBR55G14AG	VS.PFG80NBR55N009	AVS.N009G14AG	1/4	5.5	80	25	10	17	150	25	51.2	260
WS.PFYN80SI55G14AG	VS.PFG80SI55N009	AVS.N009G14AG	1/4	5.5	80	25	10	17	150	25	52.8	260
WS.PFYN80HT160G14AG	VS.PFG80HT160N009	AVS.N009G14AG	1/4	5.5	80	25	10	17	150	25	50.5	260
WS.PFYN95NBR55G14AG	VS.PFG95NBR55N009	AVS.N009G14AG	1/4	5.5	95	25.5	10	17	200	35	92.4	350
WS.PFYN95SI55G14AG	VS.PFG95SI55N009	AVS.N009G14AG	1/4	5.5	95	25.5	10	17	200	35	87.9	350

Ventose piane ovali con nipplo

Oval flat vacuum cups with nipple

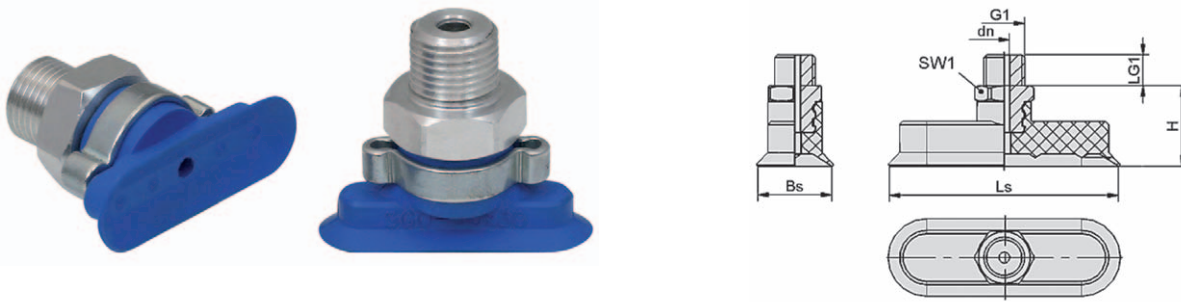

	Ventosa <i>Vacuum cup</i>	Nipplo <i>Nipple</i>	G1	dn	B	H	L	LG1	SW1	R	V	m	F
			[mm]	[mm]	[mm]	[mm]	[mm]	[mm]	[mm]	[mm]	[cm ³]	[g]	[N]
WS.SGON4X2HT1M3AG	VS.SG04X2HT160N003	AVS.N003M3AG100	M3	1	2	8	4	3	5	1	0.004	0.28	0.42
WS.SGON4X2NBRM3AG	VS.SG04X2NBR60N003	AVS.N003M3AG100	M3	1	2	8	4	3	5	1	0.004	0.28	0.42
WS.SGON7X3.5HT1M3AG	VS.SG07X3.5HT160N003	AVS.N003M3AG100	M3	1	3.5	8	7	3	5	3	0.019	0.28	1
WS.SGON7X3.5NBRM3AG	VS.SG07X3.5NBR60N003	AVS.N003M3AG100	M3	1	3.5	8	7	3	5	3	0.019	0.32	1
WS.SGON15X5HT1M5AG	VS.SG015X5HT160N021	AVS.N021M5AG200	M5	2	5	17	15	5	8	4	0.036	0.71	3.1
WS.SGON15X5NBRM5AG	VS.SG015X5NBR60N021	AVS.N021M5AG200	M5	2	5	17	15	5	8	4	0.036	0.71	3.1
WS.SGON18X6HT1M5AG	VS.SG018X6HT160N021	AVS.N021M5AG200	M5	2	6	17	18	5	8	4	0.058	0.71	4.5
WS.SGON18X6NBRM5AG	VS.SG018X6NBR60N021	AVS.N021M5AG200	M5	2	6	17	18	5	8	4	0.058	0.71	4.5
WS.SGON24X8HT1G18AG	VS.SG024X8HT160N022	AVS.N022G18AG350	1/8	3.5	8	17	24	8	14	8	0.138	6.4	8
WS.SGON24X8NBRG18AG	VS.SG024X8NBR60N022	AVS.N022G18AG350	1/8	3.5	8	17	24	8	14	8	0.138	6.4	8
WS.SGON30X10HT1G18AG	VS.SG030X10HT160N022	AVS.N022G18AG350	1/8	3.5	10	17	30	8	14	8	0.28	6.6	12.2
WS.SGON30X10NBRG18AG	VS.SG030X10NBR60N022	AVS.N022G18AG350	1/8	3.5	10	17	30	8	14	8	0.28	6.5	12.2
WS.SGON45X15HT1G14AG	VS.SG045X15HT160N023	AVS.N023G14AG350	1/4	3.5	15	26	45	10	17	10	0.98	15.9	28.2
WS.SGON45X15NBRG14AG	VS.SG045X15NBR60N023	AVS.N023G14AG350	1/4	3.5	15	26	45	10	17	10	0.98	15.9	28.2
WS.SGON60X20HT1G14AG	VS.SG060X20HT160N023	AVS.N023G14AG350	1/4	3.5	20	26	60	9.95	17	20	2.3	19.3	50.1
WS.SGON60X20NBRG14AG	VS.SG060X20NBR60N023	AVS.N023G14AG350	1/4	3.5	20	26	60	9.95	17	20	2.3	19.3	50.1
WS.SGON75X25NBRG14AG	VS.SG075X25NBR60N023	AVS.N023G14AG350	1/4	3.5	25	26	75	10	17	30	4.7	27.4	78.3
WS.SGON75X25HT1G14AG	VS.SG075X25HT160N023	AVS.N023G14AG350	1/4	3.5	25	26	75	10	17	30	4.7	27.4	78.3
WS.SGON90X30NBRG14AG	VS.SG090X30NBR70N023	AVS.N023G14AG350	1/4	3.5	30	26	90	10	17	35	8.5	35.6	112.6

Ventose con 1.5 soffietti con nipplo

Vacuum cups with 1.5 bellows with nipple

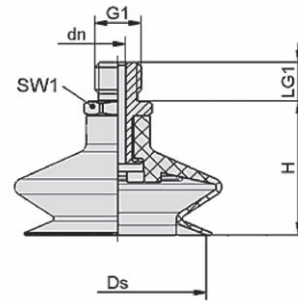
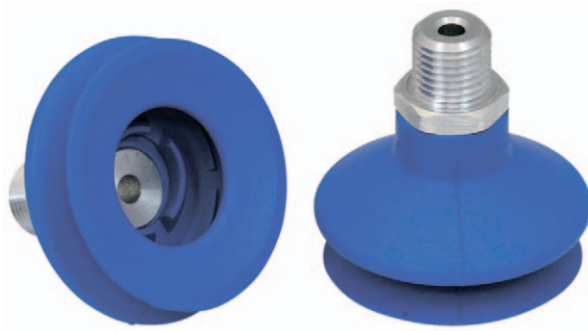

	Ventosa Vacuum cup	Nipplo Nipple	G1 [mm]	dn [mm]	Ds [mm]	H [mm]	LG1 [mm]	SW1 [mm]	R [mm]	V [cm ³]	m [g]	F [N]
WS.FSGA11HT160G18AG	VS.FGA11HT160N016	AVS.N016G18AG350	1/8	3.5	10.4	22	7.5	14	10	0.225	5.03	0.95
WS.FSGA11HT160M5AG	VS.FGA11HT160N016	AVS.N016M5AG250	M5	2.5	10.4	21	5	7	10	0.225	1.92	0.95
WS.FSGA11NBR55G18AG	VS.FGA11NBR55N016	AVS.N016G18AG350	1/8	3.5	10.4	22	7.5	14	10	0.225	5.03	0.95
WS.FSGA11NBR55M5AG	VS.FGA11NBR55N016	AVS.N016M5AG250	M5	2.5	10.4	21	5	7	10	0.225	1.92	0.95
WS.FSGA11SI55G18AG	VS.FGA11SI55N016	AVS.N016G18AG350	1/8	3.5	10.4	22	7.5	14	10	0.225	5.03	0.95
WS.FSGA11SI55M5AG	VS.FGA11SI55N016	AVS.N016M5AG250	M5	2.5	10.4	21	5	7	10	0.225	1.92	0.95
WS.FSGA16HT160G18AG	VS.FGA16HT160N016	AVS.N016G18AG350	1/8	3.5	15.6	25.2	7.5	14	20	0.75	5.33	2.3
WS.FSGA16HT160M5AG	VS.FGA16HT160N016	AVS.N016M5AG250	M5	2.5	15.6	24.2	5	7	20	0.75	2.32	2.3
WS.FSGA16NBR55G18AG	VS.FGA16NBR55N016	AVS.N016G18AG350	1/8	3.5	15.6	25.2	7.5	14	20	0.75	5.33	2.3
WS.FSGA16NBR55M5AG	VS.FGA16NBR55N016	AVS.N016M5AG250	M5	2.5	15.6	24.2	5	7	20	0.75	2.22	2.3
WS.FSGA16SI55G18AG	VS.FGA16SI55N016	AVS.N016G18AG350	1/8	3.5	15.6	25.2	7.5	14	20	0.75	5.43	2.3
WS.FSGA16SI55M5AG	VS.FGA16SI55N016	AVS.N016M5AG250	M5	2.5	15.6	24.2	5	7	20	0.75	2.22	2.3
WS.FSGA22HT160G18AG	VS.FGA22HT160N016	AVS.N016G18AG350	1/8	3.5	21.5	25	7.5	14	25	1.4	6.03	5.7
WS.FSGA22HT160M5AG	VS.FGA22HT160N016	AVS.N016M5AG250	M5	2.5	21.5	24	5	7	25	1.4	2.92	5.7
WS.FSGA22NBR55G18AG	VS.FGA22NBR55N016	AVS.N016G18AG350	1/8	3.5	21.5	25	7.5	14	25	1.4	5.93	5.7
WS.FSGA22NBR55M5AG	VS.FGA22NBR55N016	AVS.N016M5AG250	M5	2.5	21.5	24	5	7	25	1.4	2.92	5.7
WS.FSGA22SI55G18AG	VS.FGA22SI55N016	AVS.N016G18AG350	1/8	3.5	21.5	25	7.5	14	25	1.4	6.02	5.7
WS.FSGA22SI55M5AG	VS.FGA22SI55N016	AVS.N016M5AG250	M5	2.5	21.5	24	5	7	25	1.4	2.82	5.7
WS.FSGA33HT160G14AG	VS.FGA33HT160N018	AVS.N018G14AG440	1/4	4.4	30	31	11	17	40	4.75	15.05	13.6
WS.FSGA33NBR55G14AG	VS.FGA33NBR55N018	AVS.N018G14AG440	1/4	4.4	30	31	11	17	40	4.75	15.05	13.6
WS.FSGA33SI55G14AG	VS.FGA33SI55N018	AVS.N018G14AG440	1/4	4.4	30	31	11	17	40	4.75	14.75	13.6
WS.FSGA43HT160G14AG	VS.FGA43HT160N018	AVS.N018G14AG440	1/4	4.4	38	31.6	11	17	60	9.25	19.25	22.8
WS.FSGA43NBR55G14AG	VS.FGA43NBR55N018	AVS.N018G14AG440	1/4	4.4	38	31.6	11	17	60	9.25	19.35	22.8
WS.FSGA43SI55G14AG	VS.FGA43SI55N018	AVS.N018G14AG440	1/4	4.4	38	31.6	11	17	60	9.25	18.75	22.8
WS.FSGA53HT160G14AG	VS.FGA53HT160N018	AVS.N018G14AG440	1/4	4.4	50	38	11	17	75	26.25	27.15	51.3
WS.FSGA53NBR55G14AG	VS.FGA53NBR55N018	AVS.N018G14AG440	1/4	4.4	50	38	11	17	75	26.25	27.05	51.3
WS.FSGA53SI55G14AG	VS.FGA53SI55N018	AVS.N018G14AG440	1/4	4.4	50	38	11	17	75	26.25	26.15	51.3
WS.FSGA78NBR55G14AG	VS.FGA78NBR55N019	AVS.N019G14AG	1/4	8.2	74	53	11	21	70	76	74.20	137.4
WS.FSGA78SI55G14AG	VS.FGA78SI55N019	AVS.N019G14AG	1/4	8.2	74	53	11	21	70	76	72.6	137.4
WS.FSGA78HT160G14AG	VS.FGA78HT160N019	AVS.N019G14AG	1/4	8.2	74	53	11	21	70	76	68.5	137.4

Ventose con 2.5 soffiotti con nipplo

Vacuum cups with 2.5 bellows with nipple

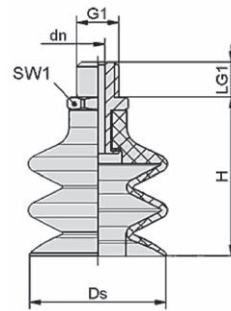

	Ventosa Vacuum cup	Nipplo Nipple	G1 [mm]	dn [mm]	Ds [mm]	H [mm]	LG1 [mm]	SW1 [mm]	R [mm]	V [cm³]	m [g]	F [N]
WS.FSG5HT160M5AG	VS.FG5HT160N017	AVS.N017M5AG200	M5	2	5	19	5	8	8	0.033	1.4	0.1
WS.FSG5NBR55M5AG	VS.FG5NBR55N017	AVS.N017M5AG200	M5	2	5	19	5	8	8	0.033	1.4	0.1
WS.FSG5SI55M5AG	VS.FG5SI55N017	AVS.N017M5AG200	M5	2	5	19	5	8	8	0.033	1.4	0.1
WS.FSG9HT160G18AG	VS.FG9HT160N016	AVS.N016G18AG350	1/8	3.5	9	21	7.5	14	10	0.15	4.73	0.7
WS.FSG9HT160M5AG	VS.FG9HT160N016	AVS.N016M5AG250	M5	2.5	9	20	5	7	10	0.15	1.62	0.7
WS.FSG9NBR55G18AG	VS.FG9NBR55N016	AVS.N016G18AG350	1/8	3.5	9	21	7.5	14	10	0.15	4.73	0.7
WS.FSG9NBR55M5AG	VS.FG9NBR55N016	AVS.N016M5AG250	M5	2.5	9	20	5	7	10	0.15	1.62	0.7
WS.FSG9SI55G18AG	VS.FG9SI55N016	AVS.N016G18AG350	1/8	3.5	9	21	7.5	14	10	0.15	4.73	0.7
WS.FSG9SI55M5AG	VS.FG9SI55N016	AVS.N016M5AG250	M5	2.5	9	20	5	7	10	0.15	1.62	0.7
WS.FSG12HT160G18AG	VS.FG12HT160N016	AVS.N016G18AG350	1/8	3.5	12	27	7.5	14	13	0.6	5.23	0.9
WS.FSG12HT160M5AG	VS.FG12HT160N016	AVS.N016M5AG250	M5	2.5	12	26	5	7	13	0.6	2.12	0.9
WS.FSG12NBR55G18AG	VS.FG12NBR55N016	AVS.N016G18AG350	1/8	3.5	12	27	7.5	14	13	0.6	5.23	0.9
WS.FSG12NBR55M5AG	VS.FG12NBR55N016	AVS.N016M5AG250	M5	2.5	12	26	5	7	13	0.6	2.12	0.9
WS.FSG12SI55G18AG	VS.FG12SI55N016	AVS.N016G18AG350	1/8	3.5	12	27	7.5	14	13	0.6	5.23	0.9
WS.FSG12SI55M5AG	VS.FG12SI55N016	AVS.N016M5AG250	M5	2.5	12	26	5	7	13	0.6	2.12	0.9
WS.FSG14HT160G18AG	VS.FG14HT160N016	AVS.N016G18AG350	1/8	3.5	14.5	28	7.5	14	15	0.975	5.53	1.2
WS.FSG14HT160M5AG	VS.FG14HT160N016	AVS.N016M5AG250	M5	2.5	14.5	27	5	7	15	0.975	2.42	1.2
WS.FSG14NBR55G18AG	VS.FG14NBR55N016	AVS.N016G18AG350	1/8	3.5	14.5	28	7.5	14	15	0.975	5.43	1.2
WS.FSG14NBR55M5AG	VS.FG14NBR55N016	AVS.N016M5AG250	M5	2.5	14.5	27	5	7	15	0.975	2.42	1.2
WS.FSG14SI55G18AG	VS.FG14SI55N016	AVS.N016G18AG350	1/8	3.5	14.5	28	7.5	14	15	0.975	5.53	1.2
WS.FSG14SI55M5AG	VS.FG14SI55N016	AVS.N016M5AG250	M5	2.5	14.5	27	5	7	15	0.975	2.32	1.2
WS.FSG18HT160G18AG	VS.FG18HT160N016	AVS.N016G18AG350	1/8	3.5	17.2	28	7.5	14	20	1.35	6.03	2.3
WS.FSG18HT160M5AG	VS.FG18HT160N016	AVS.N016M5AG250	M5	2.5	17.2	27	5	7	20	1.35	3.12	2.3
WS.FSG18NBR55G18AG	VS.FG18NBR55N016	AVS.N016G18AG350	1/8	3.5	17.2	28	7.5	14	20	1.35	6.03	2.3
WS.FSG18NBR55M5AG	VS.FG18NBR55N016	AVS.N016M5AG250	M5	2.5	17.2	27	5	7	20	1.35	2.92	2.3
WS.FSG18SI55G18AG	VS.FG18SI55N016	AVS.N016G18AG350	1/8	3.5	17.2	28	7.5	14	20	1.35	6.23	2.3
WS.FSG18SI55M5AG	VS.FG18SI55N016	AVS.N016M5AG250	M5	2.5	17.2	27	5	7	20	1.35	2.92	2.3
WS.FSG20HT160G18AG	VS.FG20HT160N016	AVS.N016G18AG350	1/8	3.5	20	28	7.5	14	30	2	6.13	3.8
WS.FSG20HT160M5AG	VS.FG20HT160N016	AVS.N016M5AG250	M5	2.5	20	27	5	7	30	2	3.22	3.8
WS.FSG20NBR55G18AG	VS.FG20NBR55N016	AVS.N016G18AG350	1/8	3.5	20	28	7.5	14	30	2	6.13	3.8
WS.FSG20NBR55M5AG	VS.FG20NBR55N016	AVS.N016M5AG250	M5	2.5	20	27	5	7	30	2	3.02	3.8
WS.FSG20SI55G18AG	VS.FG20SI55N016	AVS.N016G18AG350	1/8	3.5	20	28	7.5	14	30	2	6.33	3.8
WS.FSG20SI55M5AG	VS.FG20SI55N016	AVS.N016M5AG250	M5	2.5	20	27	5	7	30	2	3.02	3.8
WS.FSG32HT160G14AG	VS.FG32HT160N018	AVS.N018G14AG440	1/4	4.4	32	41.5	11	17	35	10	17.25	12
WS.FSG32NBR55G14AG	VS.FG32NBR55N018	AVS.N018G14AG440	1/4	4.4	32	41.5	11	17	35	10	17.25	12
WS.FSG32SI55G14AG	VS.FG32SI55N018	AVS.N018G14AG440	1/4	4.4	32	41.5	11	17	35	10	17.25	12
WS.FSG42HT160G14AG	VS.FG42HT160N018	AVS.N018G14AG440	1/4	4.4	42.6	50	11	17	75	19.5	28.65	13.6
WS.FSG42NBR55G14AG	VS.FG42NBR55N018	AVS.N018G14AG440	1/4	4.4	42.6	50	11	17	75	19.5	30.25	13.6
WS.FSG42SI55G14AG	VS.FG42SI55N018	AVS.N018G14AG440	1/4	4.4	42.6	50	11	17	75	19.5	28.35	13.6
WS.FSG62HT160G14AG	VS.FG62HT160N018	AVS.N018G14AG440	1/4	4.4	62.2	59	11	17	75	72.5	48.05	39.6
WS.FSG62NBR55G14AG	VS.FG62NBR55N018	AVS.N018G14AG440	1/4	4.4	62.2	59	11	17	75	72.5	49.85	39.6
WS.FSG62SI55G14AG	VS.FG62SI55N018	AVS.N018G14AG440	1/4	4.4	62.2	59	11	17	75	72.5	45.85	39.6
WS.FSG88NBR55G14AG	VS.FG88NBR55N019	AVS.N019G14AG	1/4	8	89	92	11	21	100	165	180.8	45.2
WS.FSG88SI55G14AG	VS.FG88SI55N019	AVS.N019G14AG	1/4	8	89	92	11	21	100	165	169.8	45.2